



- Different voltage ranges according to EN 60309
- Large temperature range of use
- High mechanical impact and shock resistance
- Perfect protection against penetration of liquids and dusts
- 3D data for download on the website
- Variants for use in USA/Canada available on request

E3

MY R. STAHL 8570N



The R. STAHL 8570/11 series SolConeX sockets for Zone 1/21 in a 3-, 4- and 5-pole version have full AC-3 switching capacity up to 16 A. The high degree of protection IP66 ensures maximum protection against the ingress of dust and water in any application position. Self-cleaning lamellar contacts provide optimum contact and the plugs can be inserted and removed in the zero position quickly and easily. The load disconnect switch, with mechanical locking device and a handle that can be locked in the 0 or I position, is an additional safety feature.

Further product options available:

- Further voltage ranges according to EN 60309
- Silicone-free versions
- Ex e or Ex i auxiliary contacts for control and signalling purposes – can also be retrofitted
- With NAMUR resistor circuitry
- External earth connection
- Customer-specific label plates
- Plates also in stainless steel
- Additional entries – also in metal

	IECEX / ATEX					
Zone	0	1	2	20	21	22
Installation in		•	•		•	•

Selection Table									
Product description									
16 A wall-mounting socket									
Figure	Detailed number of poles	Coding (clock hour position)	AC rated operational voltage	Rated operational voltage DC	Colour code	Frequency range	Product Type	Art. No.	Weight
	1 P + N + PE	4	100 ... 130 V AC	–	Yellow	50 / 60 Hz	8570/11-304-S-01-0-00-XXX	273933	1.12 kg
		5	277 V AC	–	Light grey	60 Hz	8570/11-305-S-01-0-00-XXX	273934	1.12 kg

Selection Table

Product description		16 A wall-mounting socket							
Figure	Detailed number of poles	Coding (clock hour position)	AC rated operational voltage	Rated operational voltage DC	Colour code	Frequency range	Product Type	Art. No.	Weight
	2 P + PE	2	> 50 V AC	–	Green	> 300 – 500 Hz	8570/11-302-S-01-0-00-XXX	273931	1.12 kg
		3	> 50 ... 110 V DC	50 ... 110 V	Light grey	–	8570/11-303-S-01-0-00-XXX	273932	1.12 kg
		6	200 ... 250 V AC	–	Blue	50 / 60 Hz	8570/11-306-S-01-0-00-XXX	273935	1.12 kg
		7	480 ... 500 V AC	–	Black	50 / 60 Hz	8570/11-307-S-01-0-00-XXX	273936	1.12 kg
		9	380 ... 415 V AC	–	Red	50 / 60 Hz	8570/11-309-S-01-0-00-XXX	273937	1.12 kg
	3 P + N + PE	3	220/380 V AC	–	Red	50 Hz	8570/11-503-S-01-0-00-XXX	273850	1.45 kg
		4	57/100 ... 75/130 V AC	–	Yellow	50 / 60 Hz	8570/11-504-S-01-0-00-XXX	273839	1.45 kg
		5	347/600 ... 400/690 V AC	–	Black	50 / 60 Hz	8570/11-505-S-01-0-00-XXX	273897	1.45 kg
		6	200/346 ... 240/415 V AC	–	Red	50 / 60 Hz	8570/11-506-S-01-0-00-XXX	273898	1.45 kg
		7	277/480 ... 288/500 V AC	–	Black	50 / 60 Hz	8570/11-507-S-01-0-00-XXX	273899	1.45 kg
		9	120/208 ... 144/250 V AC	–	Blue	50 / 60 Hz	8570/11-509-S-01-0-00-XXX	273900	1.45 kg
		11	250/440 ... 265/460 V AC	–	Red	60 Hz	8570/11-511-S-01-0-00-XXX	273921	1.45 kg
	3 P + PE	2	> 50 V AC	–	Green	> 300 – 500 Hz	8570/11-402-S-01-0-00-XXX	273922	1.35 kg
		3	380 V AC	–	Red	50 Hz	8570/11-403-S-01-0-00-XXX	273923	1.35 kg
		4	100 ... 130 V AC	–	Yellow	50 / 60 Hz	8570/11-404-S-01-0-00-XXX	273924	1.35 kg
		5	600 ... 690 V AC	–	Black	50 / 60 Hz	8570/11-405-S-01-0-00-XXX	273925	1.35 kg
		6	380 ... 415 V AC	–	Red	50 / 60 Hz	8570/11-406-S-01-0-00-XXX	273926	1.35 kg
		7	480 ... 500 V AC	–	Black	50 / 60 Hz	8570/11-407-S-01-0-00-XXX	273927	1.35 kg
		9	200 ... 250 V AC	–	Blue	50 / 60 Hz	8570/11-409-S-01-0-00-XXX	273928	1.35 kg
		10	> 50 V AC	–	Green	100 – 300 Hz	8570/11-410-S-01-0-00-XXX	273929	1.35 kg
		11	440 ... 460 V AC	–	Red	60 Hz	8570/11-411-S-01-0-00-XXX	273930	1.35 kg

Technical Data

Variant	16 A wall-mounting socket
Explosion Protection	
Area of application	European Union (ATEX) IECEX
Area of application Note	Other country markings available on request
IECEX gas explosion protection	Ex db eb IIC T6 ... T5 Gb
IECEX dust explosion protection	Ex tb IIIC T73 °C Db
ATEX gas explosion protection	Ⓔ II 2 G Ex db eb IIC T6 ... T5 Gb
ATEX dust explosion protection	Ⓔ II 2 D Ex tb IIIC T73 °C Db
Certificates	ATEX (PTB), Brazil (ULB), China (CQST), IECEX (PTB), India (PESO), Korea (KTL), Taiwan (ITRI)
Ship approval	DNV

Technical Data	
Variant	16 A wall-mounting socket
Explosion Protection	
Declaration of conformity	ATEX (EUK), China (CCC)
Electrical Data	
Rated operational current	16 A
Rated operational current note	Usable for up to 20 A depending on the connection cross-section
Utilisation category	AC-3: 690 V / 16 A AC-3: 500 V / 20 A DC-1: 110 V / 16 A UL508: 600 V / 20 A
Switching capacity main contacts	4 kW: 200 to 250 V AC 7.5 kW: 380 to 500 V AC 11 kW: 600 to 690 V AC
Notes	The current must be reduced to 12 A for frequencies ≥ 100 Hz
Device Specific Data	
Back-up fuse with thermal protection	35 A gG
Back-up fuse without thermal protection	16 A gG
Ambient Conditions	
Ambient temperature	-50 °C to +65 °C
Notes	For further information, see the operating instructions.
Mechanical Data	
Degree of protection IP (IEC 60529)	IP66
IP degree of protection (IEC 60079)	IP64
Enclosure material	Polyamide, Glass fibre reinforced
Silicone-free	No
Solid connection cross-section	1 x 1.5 mm ² ... 2 x 6 mm ²
Finely stranded connection cross-section	1 x 1.5 mm ² ... 2 x 4 mm ²
Impact strength (IEC 60079)	7 J
Impact strength (IEC 62262)	IK10
Lockable in	in 0- and I-position
Interlock	Prevents the plug from being pulled under load
Components	
Cable entry note	Entry 1: Lower left Entry 2: Lower right
Entry 1 model	8161/7-M25-1707-LT
Entry 1 type	Polyamide cable gland
Entry 1	M25 x 1.5
Entry 1 clamping range	7 – 17 mm
Entry 1 clamping range	7 – 17 mm
Metal entry possible 1	No
Entry 2 model	8290/3-M25
Entry 2 type	Polyamide stopping plug
Entry 2	M25 x 1.5
Metal entry possible 2	No

Arrangement of earth contact sleeves

Position of clock hour position
Example: 6 h position

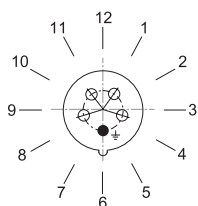

Arrangement of socket contacts and terminal markings

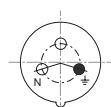

1 P + N + PE

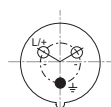

2 P + PE

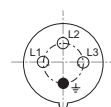

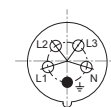

3 P + PE







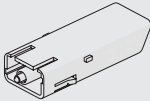
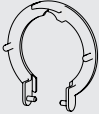
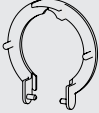
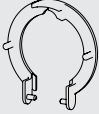

3 P + N + PE

Arrangement of the socket contacts and terminal markings in the 6 h position
(view from the front side of the sockets to the socket contacts)

Accessories

Figure	Description	Art. No.	Weight
Auxiliary contact optional, pluggable by the user, easy to retrofit			
	1 NC Max. 500 V AC, max. 110 V DC Max. 6 A 1 x 0.5 to 2 x 2.5 mm ² , solid/finely stranded	150680	125 g
	1 NC, gold-plated contact Max. 500 V AC, max. 110 V DC Max. 6 A 1 x 0.5 to 2 x 2.5 mm ² , solid/finely stranded	150684	125 g
	1 NO Max. 500 V AC, max. 110 V DC Max. 6 A 1 x 0.5 to 2 x 2.5 mm ² , solid/finely stranded	150682	125 g
	1 NO, gold-plated contact Max. 500 V AC, max. 110 V DC Max. 6 A 1 x 0.5 to 2 x 2.5 mm ² , solid/finely stranded	150686	125 g
Dust cover for sockets, series 8570			
	Retrofittable dust protection for 3-pole sockets	253118	6 g
Dust cover for sockets, Series 8570			
	Retrofittable dust protection for 4-pole sockets	255003	8 g
Dust cover for sockets, series 8570			
	Retrofittable dust protection for 5-pole sockets	255004	8 g
Plug			
	8570/12-307-S-XX-X-XX-XXX 3-pole plug, 480 to 500 V AC, 50/60 Hz, 16 A	272899	331 g
	8570/12-405-S-XX-X-XX-XXX 4-pole plug, 600 to 690 V AC, 50/60 Hz, 16 A	272888	384 g
	8570/12-407-S-XX-X-XX-XXX 4-pole plug, 480 to 500 V AC, 50/60 Hz, 16 A	272890	384 g
	8570/12-505-S-XX-X-XX-XXX 5-pole plug, 347/600 to 400/690 V AC, 50/60 Hz, 16 A	272720	444 g
	8570/12-507-S-XX-X-XX-XXX 5-pole plug, 277/480 to 288/500 V AC, 50/60 Hz, 16 A	272882	444 g

Accessories			
Figure	Description	Art. No.	Weight
Plug			
	8570/12-309-S-XX-X-XX-XXX 3-pole plug, 380 to 415 V AC, 50/60 Hz, 16 A	272900	331 g
	8570/12-403-S-XX-X-XX-XXX 4-pole plug, 380 V AC, 50 Hz, 16 A	272886	384 g
	8570/12-406-S-XX-X-XX-XXX 4-pole plug, 380 to 415 V AC, 50/60 Hz, 16 A	272889	384 g
	8570/12-411-S-XX-X-XX-XXX 4-pole plug, 440 to 460 V AC, 60 Hz, 16 A	272893	384 g
	8570/12-503-S-XX-X-XX-XXX 5-pole plug, 220/380 V AC, 50 Hz, 16 A	272718	444 g
	8570/12-506-S-XX-X-XX-XXX 5-pole plug, 200/346 to 240/415 V AC, 50 / 60 Hz, 16 A	272881	444 g
	8570/12-511-S-XX-X-XX-XXX 5-pole plug, 250/440 to 265/460 V AC, 60 Hz, 16 A	272884	444 g
	8570/12-306-S-XX-X-XX-XXX 3-pole plug, 200 to 250 V AC, 50 / 60 Hz, 16 A	272898	331 g
	8570/12-409-S-XX-X-XX-XXX 4-pole plug, 200 to 250 V AC, 50/60 Hz, 16 A	272891	384 g
	8570/12-509-S-XX-X-XX-XXX 5-pole plug, 120/208 to 144/250 V AC, 50/60 Hz, 16 A	272883	444 g
	8570/12-304-S-XX-X-XX-XXX 3-pole plug, 100 to 130 V AC, 50/60 Hz, 16 A	272896	331 g
	8570/12-404-S-XX-X-XX-XXX 4-pole plug, 100 to 130 V AC, 50/60 Hz, 16 A	272887	384 g
	8570/12-504-S-XX-X-XX-XXX 5-pole plug, 57/100 to 75/130 V AC, 50/60 Hz, 16 A	272719	444 g
	8570/12-302-S-XX-X-XX-XXX 3-pole plug, > 50 V AC, >300 to 500 Hz, 12 A	272894	331 g
	8570/12-402-S-XX-X-XX-XXX 4-pole plug, > 50 V AC, >300 to 500 Hz, 12 A	272885	384 g
	8570/12-410-S-XX-X-XX-XXX 4-pole plug, > 50 V AC, 100 to 300 Hz, 12 A	272892	384 g
	8570/12-303-S-XX-X-XX-XXX 3-pole plug, >50 to 110 V DC, 16 A	272895	331 g
	8570/12-305-S-XX-X-XX-XXX 3-pole plug, 277 V AC, 60 Hz, 16 A	272897	331 g

Spare Parts			
Figure	Description	Art. No.	Weight
Repair set for Series 8570 sockets			
	Repair set 8570 hinged cover, 3-pole, black	274119	95 g
	Repair set 8570 hinged cover, 3-pole, blue	274116	95 g
	Repair set 8570 hinged cover, 3-pole, green	274115	95 g
	Repair set 8570 hinged cover, 3-pole, light grey	274121	95 g
	Repair set 8570 hinged cover, 3-pole, red	274118	95 g
	Repair set 8570 hinged cover, 3-pole, yellow	274117	95 g
	Repair set 8570 hinged cover, 4-pole, black	274114	115 g
	Repair set 8570 hinged cover, 4-pole, blue	274111	115 g
	Repair set 8570 hinged cover, 4-pole, green	274110	115 g
	Repair set 8570 hinged cover, 4-pole, red	274113	115 g
	Repair set 8570 hinged cover, 4-pole, yellow	274112	115 g
	Repair set 8570 hinged cover, 5-pole, black	274109	125 g
	Repair set 8570 hinged cover, 5-pole, blue	274106	125 g
	Repair set 8570 hinged cover, 5-pole, red	274108	125 g
	Repair set 8570 hinged cover, 5-pole, yellow	274107	125 g

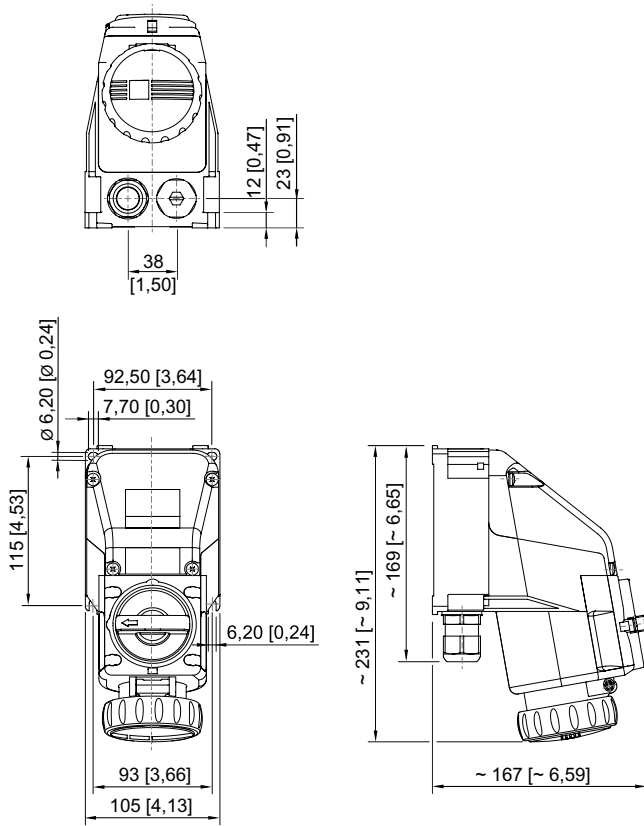

3-pole wall-mounting socket

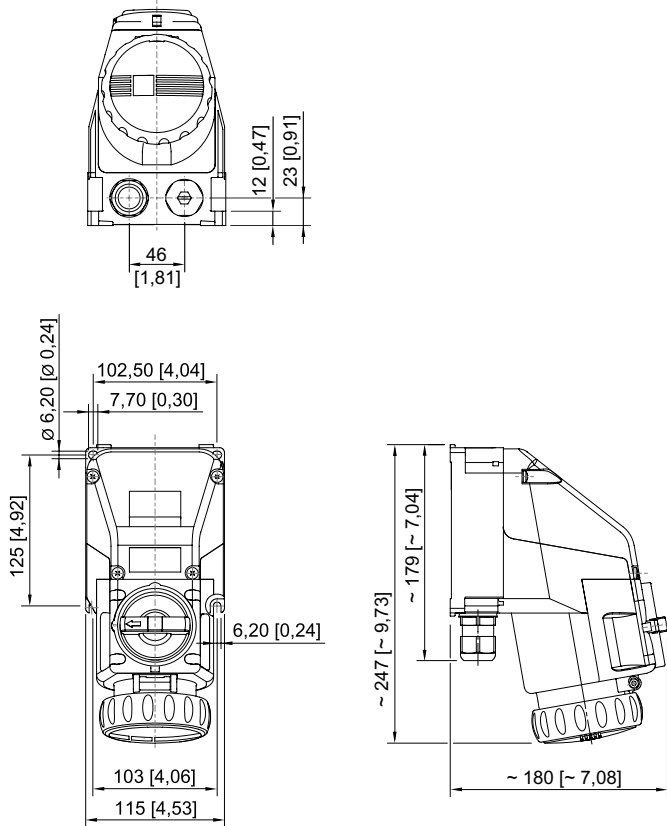

4-pole/5-pole wall-mounting socket